

Inflectional periphrasis as collocation

Olivier Bonami¹ Gert Webelhuth²

¹Université Paris Sorbonne &
Institut Universitaire de France &
Laboratoire de Linguistique Formelle

²Goethe Universität Frankfurt

8th Mediterranean Morphology Meeting
September 16, 2011

Introduction

Inflectional periphrases

- are not the result of free syntactic combinations.
- Rather: they realize cells in the inflectional paradigms of lexemes:
 - ☞ Vincent and Börjars 1996, Börjars, Vincent, and Chapman 1997, Ackerman and Webelhuth 1998, Spencer 2001, Blevins 2001, 2007 (ms), Stump 2002, Sadler and Spencer 2001, Spencer 2003, Ackerman and Stump 2004, Stump 2006, Bonami and Samvelian 2009, Bonami and Webelhuth (to appear)
- None of the proposals is compatible with all the desirable design properties of a theory of periphrasis as inflection.
- **New proposal to solve this problem: periphrastic predicates as collocations.**



Five design properties of a theory of inflectional pe

Periphrasis is independent of phrase structure

The parts of a periphrase can stand in varying phrase-structural configurations (Bonami & Webelhuth, in press):

- (1) a. dass das Buch jemand [vc gekauft hat]
 CPZR the book nobody buy.PST.PCPL have.PRS.3SG
 ‘that nobody bought the book’ (German)
- b. Paul [vp vient de [vp lire ce livre]].
 Paul come.PRS[3SG] of read.INF that book
 ‘Paul just read that book.’ (French)
- c. [s Maryam dâšt [s madrase mi-raft]].
 Maryam have.PST[3SG] school IPFV-go.PST[3SG]
 ‘Maryam was going to school.’ (Persian)
- d. [s Njama-še [CP da mu ga napratja]].
 have.NEG-IPFV CPZR to.him it send.PRS.1SG
 ‘I shan’t send it to him.’ (Bulgarian)

Auxiliaries have normal, nondefective paradigms

- Example: Persian perfect and evidential forms (Bonami & Samvelian, 2009)

		PERFECTIVE	IMPERFECTIVE	PERFECT
PRESENT		***	mi-xar-ad	xarid-e-ast
PAST	DIR.	xarid	mi-xarid	xarid-e bud
	IND.	xarid-e-ast	mi-xarid-e-ast	xarid-e bud-e-ast
SUBJUNCTIVE		be-xar-ad		xarid-e bâš-ad

- Costs of reducing the **periphrastic forms** to 'normal' syntax:
 - lexemes would be systematically defective for nonpresent [PRF +] forms (except budan)
 - budan would be defective for all [PRF -] forms
 - either budan would be defective for the present perfect or its use would be blocked by the existence of a synthetic form
 - budan would use [PRF -] morphology to express [PRF +]

Inflection is inferential-realizational, syntax is lexical-incremental

- As argued at length by, e.g.

- Hockett 1954
- Robins 1959
- Matthews 1972
- Anderson 1992
- Zwicky 1992
- Aronoff 1994
- Stump 2001
- Blevins 2006
- ...

inflectional systems are best described in word-and-paradigm approach 

- As argued at length by, e.g.

- Harman 1963
- Bresnan 1978
- Gazdar, Klein, Pullum & Sag 1985
- Pollard & Sag 1987, 1994
- Steedman 1996
- ...

syntactic systems are best described in phrase-structural terms, as incrementally built combinations of signs 

Arbitration between synthesis and periphrasis follows the logic of Pāṇini's principle

- Slovak (Stanislav 1977, quoted from Corbett 2010)

	SG	PL
1	nesiem	nesieme
2	nesieš	nesiete
3	nesie	nesú

Present of the verb NIEŠT' 'to carry'

	SG			PL
	M	F	N	
1	nesol som	nesla som	—	nesli sme
2	nesol si	nesla si	—	nesli ste
3	nesol	nesla	neslo	nesli

Past of the verb NIEŠT' 'to carry'

Periphrasis: syntactic head-argument or head-modifier relationship

Head + argument:

- (2) dass das Buch jemand [vc gekauft hat]
 that the book nobody buy.PST.PCPL have.PRS.3SG
 'that nobody bought the book'

Head + modifier:

- (3) [AP more important]

Periphrasis: extraction can distort the relationship

Head + argument:

- (4) [_{SubCl} dass Maria das Buch **gekauft** **hat**]
 that Maria the book buy.PST.PCPL have.PRS.3SG
 ‘that Maria bought the book’

Verb-second of finite verb:

- (5) [_{MainCl} Maria hat das Buch **gekauft**]
 Maria have.PRS.3SG the book buy.PST.PCPL
 ‘Maria bought the book’

Periphrasis: extraction can distort the relationship

First position of nonfinite verb:

- (6) [_{MainCl} Gekauft hat Maria das Buch]
 buy.PST.PCPL have.PRS.3SG Maria the book

‘Maria bought the book’

- (7) [_{MainCl} Gekauft wird Maria das Buch haben]
 buy will Maria the book have

‘Maria will have bought the book’

How do current theories fare?

Periphrasis as syntactic exponence: shortcomings of previous approaches



- **Ackerman and Webelhuth 1998**: syntax of periphrasis is too inflexible to handle extraction or modification
- **Sadler and Spencer 2001, Ackerman and Stump 2004**: opposite problem: syntax too unconstrained or details not worked out
- **Bonami and Samvelian 2009**: the morphological component fails to be completely realizational
- **Bonami and Webelhuth (to appear)**: Panini's Principle does not apply within the morphology, can't deal with periphrases that rest on the modifier-head relation.

An alternative: periphrases as collocations

The intuition



- The main element of a periphrase requires the presence of a selector in the same local environment
- This is reminiscent of the mutual cooccurrence requirements we find in collocations

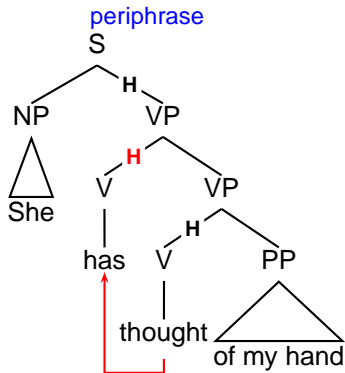
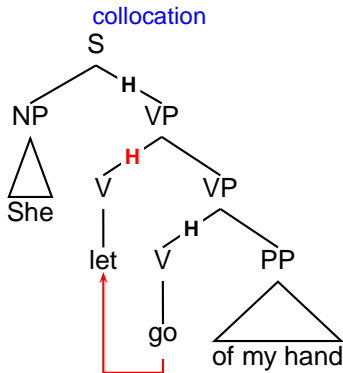

The intuition

- The same goes for modification structures

collocation

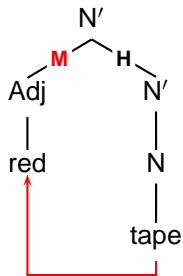

periphrase

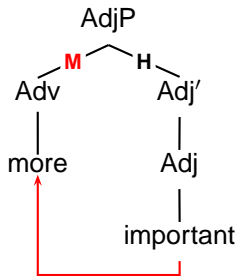

Implementing the intuition

- Prior work on collocations in HPSG: Sailer 2000, Soehn & Sailer 2003, Soehn 2006, Richter & Sailer 2009
- We adopt an analysis in the spirit of Soehn & Sailer 2003, but with important modifications.
 - Words can carry a REVERSE-SELECTION requirement
 - This amounts to asking for a selector to be present
 - The distance between selector and selectee can be as long as the grammar allows independently for kind of selection relation
- Inflection rules may produce REV-SEL requirements

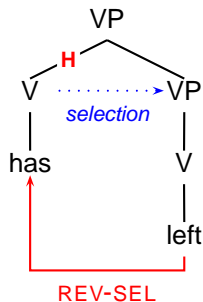

The Reverse Selection Principle

- If a word carries a REV-SEL requirement, then it should be selected by a word whose morphological description unifies with that requirement.

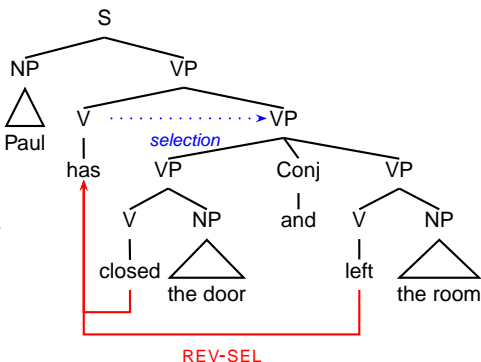
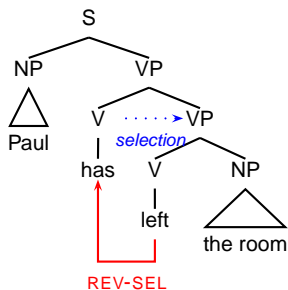

The Reverse Selection Principle (continued)

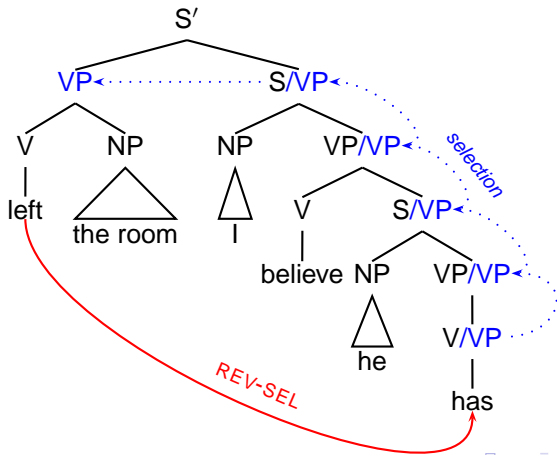

- Since we rely on the HPSG theory of selection, extraction of parts of periphrases is predicted to be possible without any further stipulations.

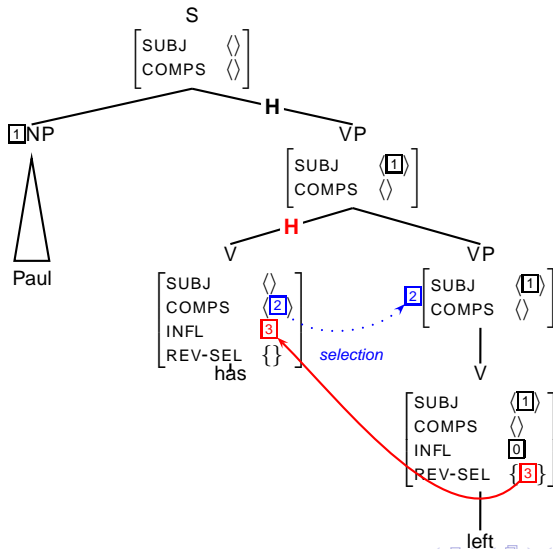

The analysis: the syntactic part



The analysis: the morphological part

- We embed a version of Paradigm Function Morphology (Stump, 2001) as a morphological component of our HPSG grammar 
- Realization rules may:
 - modify the **phonological representation** of their input 
 - add **reverse selectional requirements** on the syntactic context

$$\begin{array}{c}
 \left[\begin{array}{l} \text{PHON } X \\ \text{REV-SEL } \{\} \end{array} \right], \sigma : \left[\begin{array}{l} \text{VFORM } \textit{pst-ptcp} \\ \text{PRF } - \end{array} \right] \longrightarrow \left[\begin{array}{l} \text{PHON } \textit{Xed} \\ \text{REV-SEL } \{\} \end{array} \right] \\
 \\
 \left[\begin{array}{l} \text{PHON } X \\ \text{REV-SEL } \{\} \end{array} \right], \sigma : \left[\text{PRF } + \right] \longrightarrow \left[\begin{array}{l} \text{PHON } \textit{refer} \left(X, \sigma \setminus \left[\begin{array}{l} \text{VFORM } \textit{pst-ptcp} \\ \text{PRF } - \end{array} \right] \right) \\ \text{REV-SEL } \left\{ \left[\begin{array}{l} \text{LID } \textit{have-aux} \\ \text{MORSYN } \sigma \setminus \left[\text{PRF } - \right] \end{array} \right] \right\} \end{array} \right]
 \end{array}$$

☞ left in has left is not a past participle, but a present perfect whose phonology is referred to that of a past participle.

The analysis: putting it all together

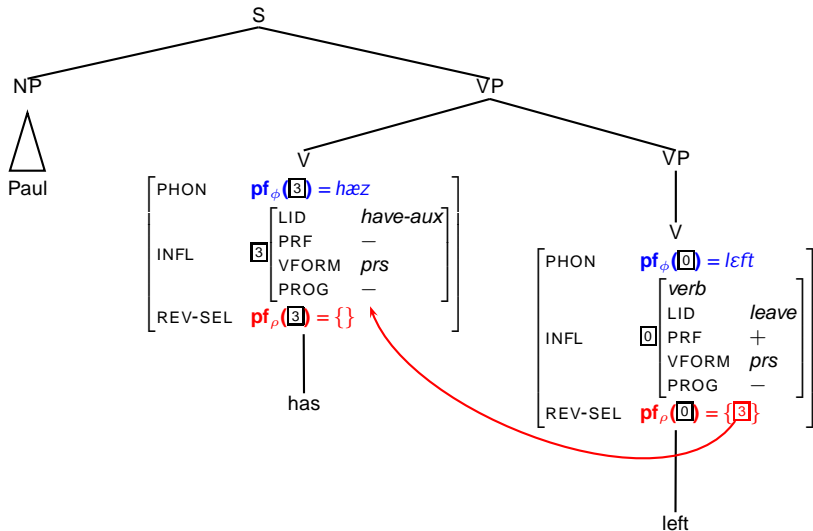

Stacking periphrases

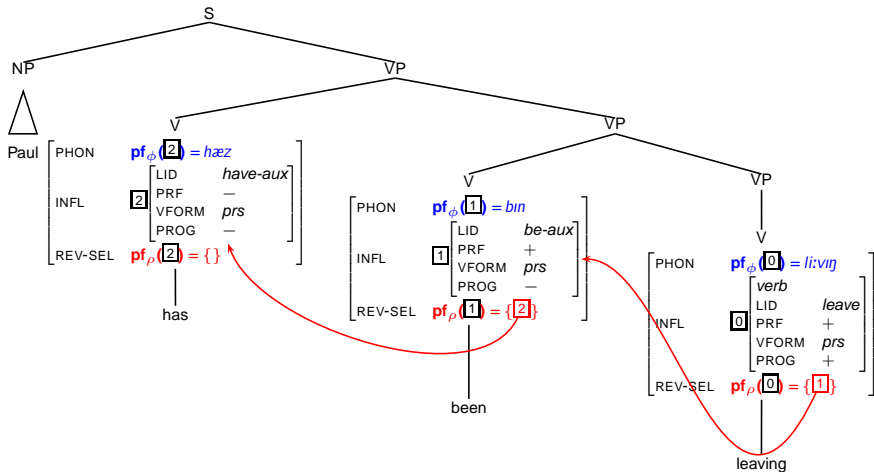

Stacking periphrases: the details

- The rule for progressive should not be applicable to perfect forms, so that we can prevent *is having left 

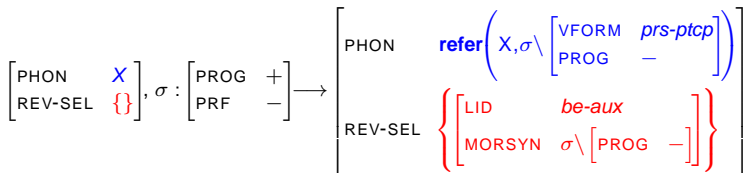

- Compare:

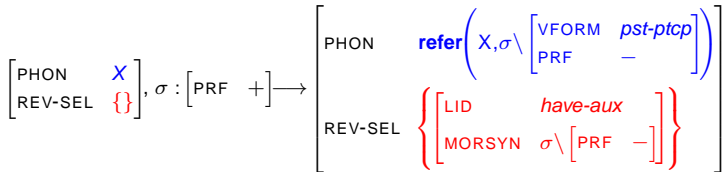

Periphrasis by modification

$$\begin{bmatrix} \text{PHON} & X \\ \text{REV-SEL} & \{\} \\ \text{ICLASS} & A \end{bmatrix}, \sigma : [\text{GRADE} \text{ comp}] \rightarrow \begin{bmatrix} \text{PHON} & Xer \\ \text{REV-SEL} & \{\} \end{bmatrix}$$

$$\begin{bmatrix} \text{PHON} & X \\ \text{REV-SEL} & \{\} \end{bmatrix}, \sigma : [\text{GRADE} \text{ comp}] \rightarrow \begin{bmatrix} \text{PHON} & X \\ \text{REV-SEL} & \{\text{LID more}\} \end{bmatrix}$$

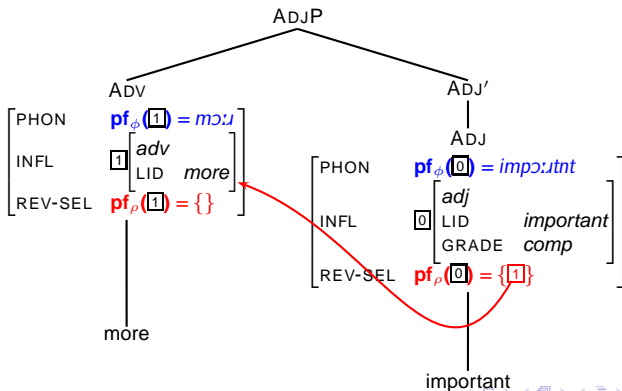

Summary and conclusions

Summary and Conclusion

Inflectional periphrases

- are not the result of free syntactic combinations.
- Rather: they realize cells in the inflectional paradigms of lexemes.
- None of the previous proposals is compatible with all the desirable design properties of a theory of periphrasis as inflection.
- **New proposal to solve this problem: periphrastic predicates as collocations.**

Summary and Conclusion

● Syntax:

- Words can carry a REVERSE-SELECTION requirement.
- This amounts to asking for a specific selector to be present in the local environment of the word.
- The distance between selector and selectee can be as long as the grammar allows independently for the selection relation involved.

● Morphology:

- The paradigm function may produce
 - phonological effects, and in addition
 - REV-SEL requirements.

The theory captures the major desiderata for a theory of periphrasis as inflection:

- The two or more exponents can stand in various syntactic relationships.
- The degree of locality of these relationships is independent of periphrasis.
- Gaps in the paradigms of auxiliaries follow from paradigm structure.
- The morphological component is realizational rather than incremental.
- Arbitration between synthesis and periphrasis is decided within the morphological component.